

This drawing is copyright. Information contained thereon is supplied in confidence and must not be used for any other purpose than which it was supplied, or be reproduced without written permission of the owners.

Diese Zeichnung ist unser geistiges Eigentum und darf ohne unsere ausdrückliche Einwilligung weder kopiert, vervielfältigt, noch Dritten oder Konkurrenzfirmen zugänglich gemacht werden.

type: **16 SMA-50-3-53**

	date	sign
drawn	3/14/00	JTH
checked	3/14/00	DDE
approved	3/14/00	MAP

Cable shortening dimension

Scale 3 : 1

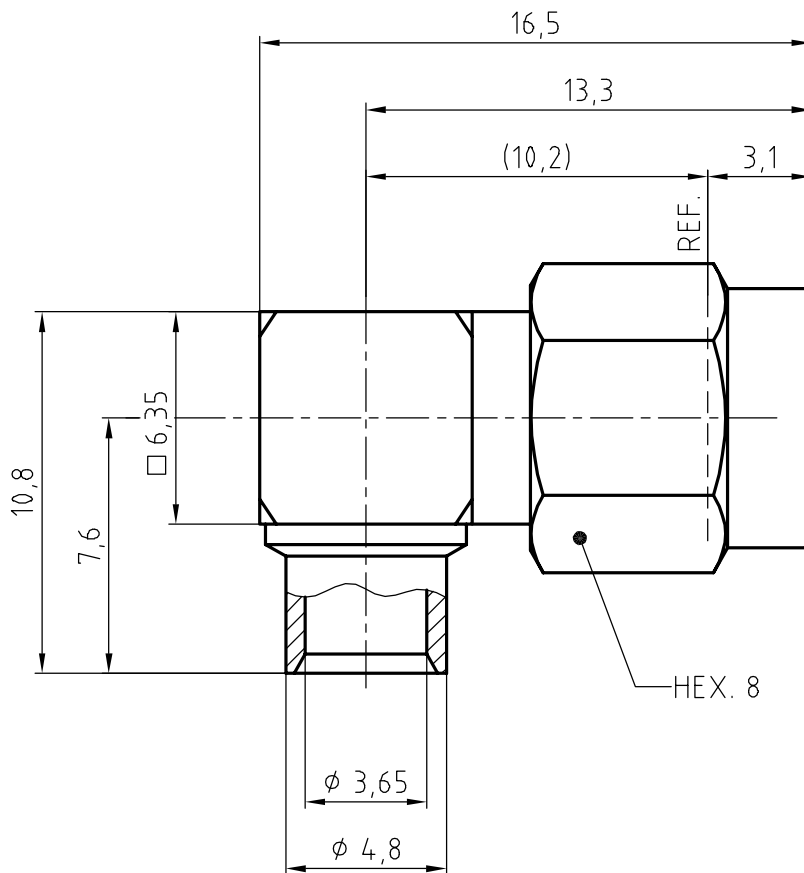
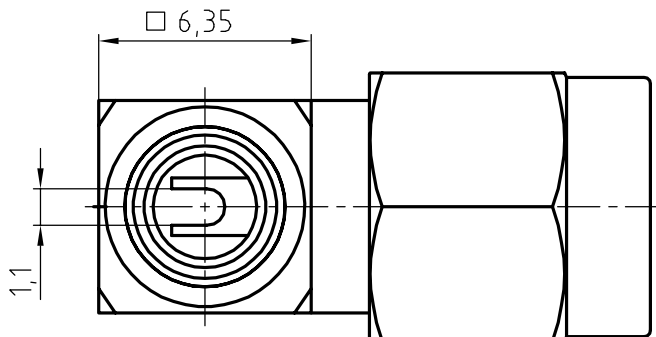
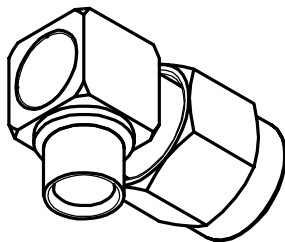
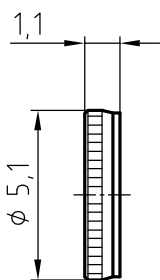
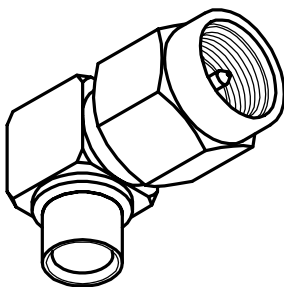
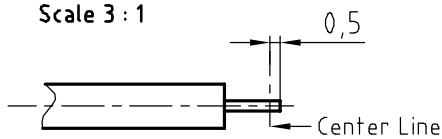

UNCONTROLLED COPY WHEN PRINTED

scale

5 : 1

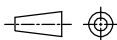

HUBER + SUHNER US-ES

dimensions in mm

drawing number

4.13.155063

QD drawing:

Index

a