

**GBM**

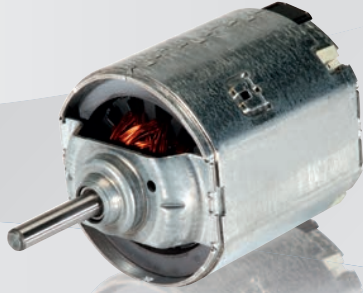

**Family features:**

- ▶ Small, medium and large sizes
- ▶ Degree of protection: IP 10
- ▶ Operation mode: S1

Voltage	Part number	Pn (Nominal power)	In (Nominal current)	nn (Nominal speed)	Mn (Nominal torque)	Ma (Stall torque)	Direction of rotation	Signal	Dimensional drawing (D)	Wiring diagram (W)	Drive end (S)	Connector (C)	Performance curve (P)
		W	A	rpm	Nm	Nm		Hall					
<b>12 V</b>	0 130 115 352	247.5	26	4300	0.55	3.00	CW	No	D2	W1	S2	C1	P2
	0 130 115 017	122.5	15	3900	0.30	1.80	CCW	No	D3	W1	S1	C1	P1
	0 130 115 008	79.5	11	3800	0.20	1.05	CCW	No	D1	W1	S3	C2	P3

**D1**

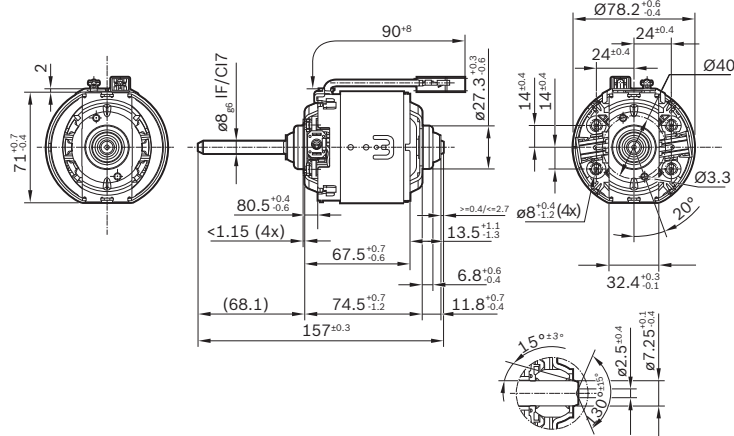

**D2**

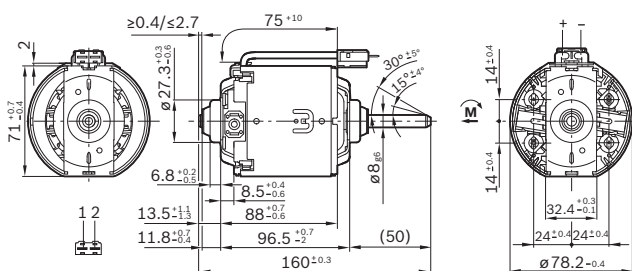

**D3**

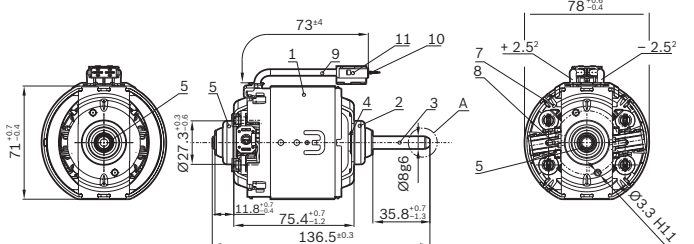

# GBM

## Wiring diagram (W)

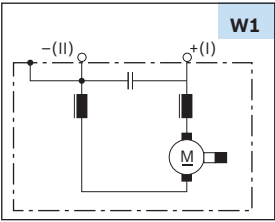

## Drive end (S)

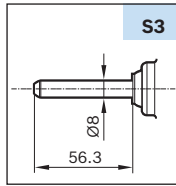
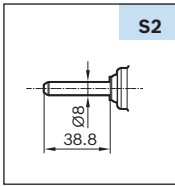
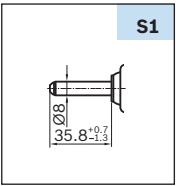

## Mating connector (C)

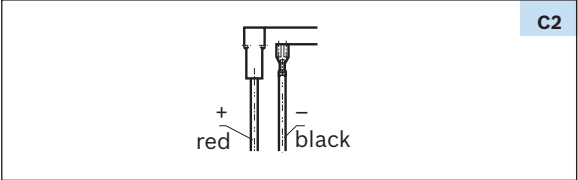
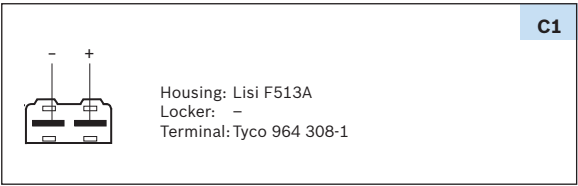

## Performance curve (P)

