

Mini Relays 24 V, 20 A

0 986 AH0 613

Change over	Normal close	Normal open
✓		

Mounting bracket	Resistor	Diode	Life durability	Current	Voltage	Number of Pins
✓	X	X	100.000	20 A	24 V	5

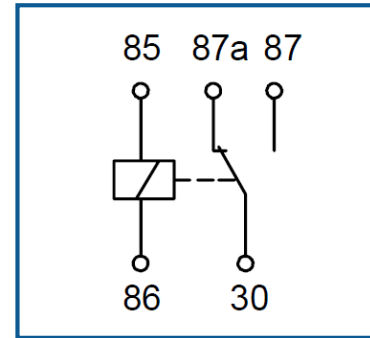
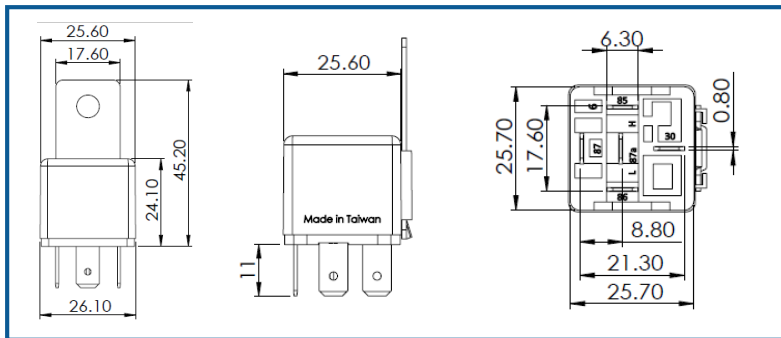

[Back to general overview](#)